



# SPAGHETTI DREADFUL

Trailer for A PENNY DREADFUL

GUSTAVE MORIN

*Spaghetti Dreadful*

Gustave Morin

Copyright © 2003 by Gustave Morin.

These poems are selections from *A Penny Dreadful*, published by Insomniac Press,  
192 Spadina Avenue, suite 403, Toronto, Ontario, Canada, M5T 2C2.

[www.insomniacpress.com](http://www.insomniacpress.com)

Cover image: from the series "Invasion of the Thunderbolt Pagoda," 1968, Ira  
Cohen. The full series can be viewed in UbuWeb's Aspen magazine section,  
[ubu.com/aspen](http://ubu.com/aspen)

[/ubu](#) editions

[www.ubu.com](http://www.ubu.com)

[/ubu](#) editions series editor: Brian Kim Stefans



# Spaghetti Dreadful

A Trailer for Insomniac Press's

A Penny  
Dreadful  
by Gustave Morin





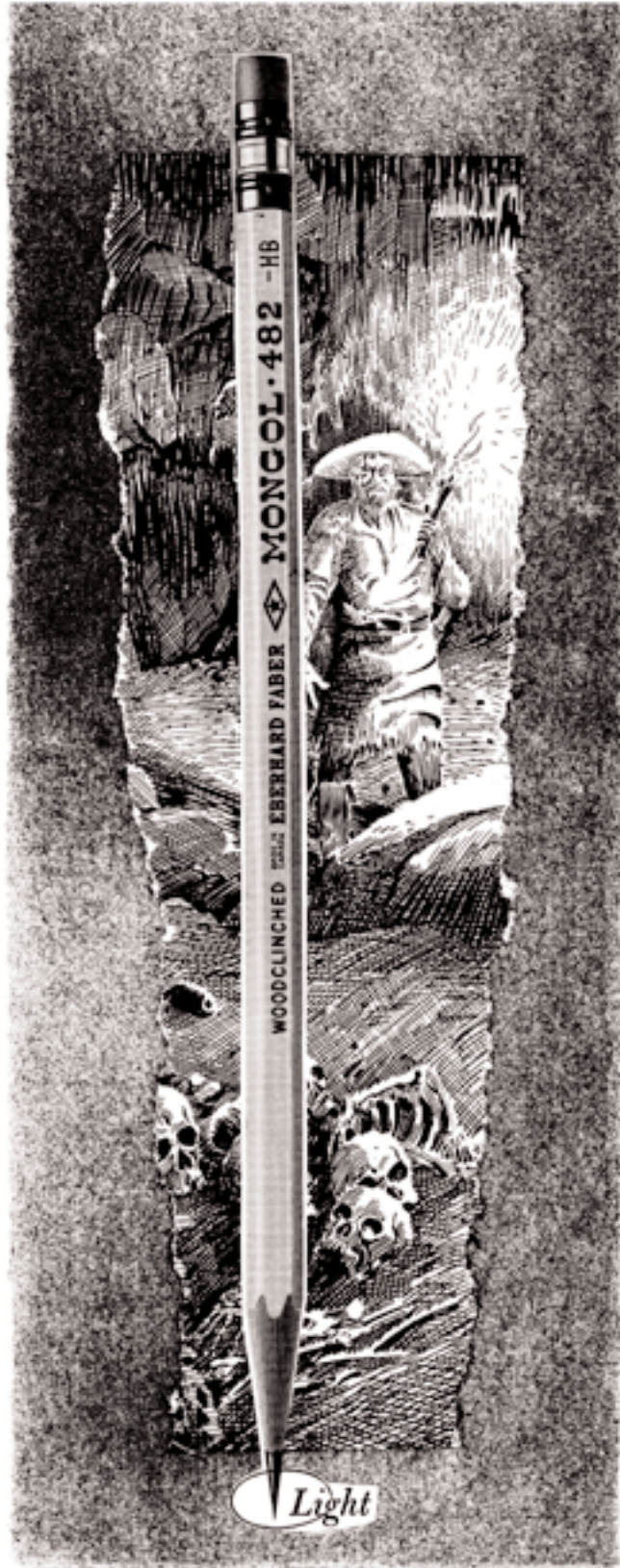

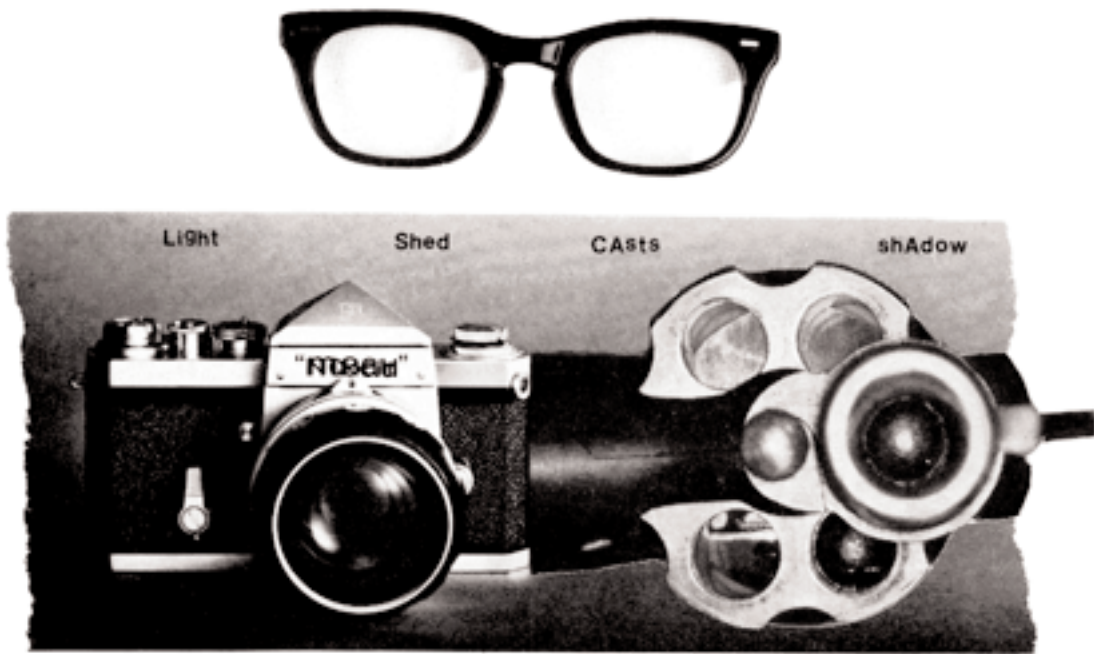





d i s t u r b i a



**The more you know**



**the harder it is to choose**



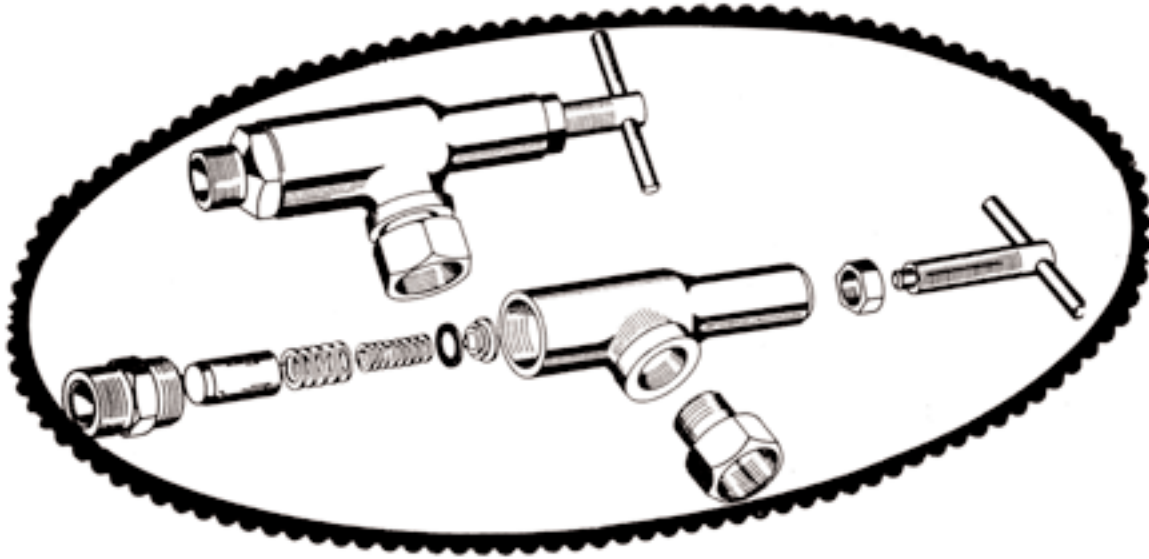

FOETUS DREAM FUNCTION

---

SOME DANGERS ARE CLEARLY  
VISIBLE TO THE NAKED EYE.

---







*always  
centered  
like this*



*never  
off center  
like this*





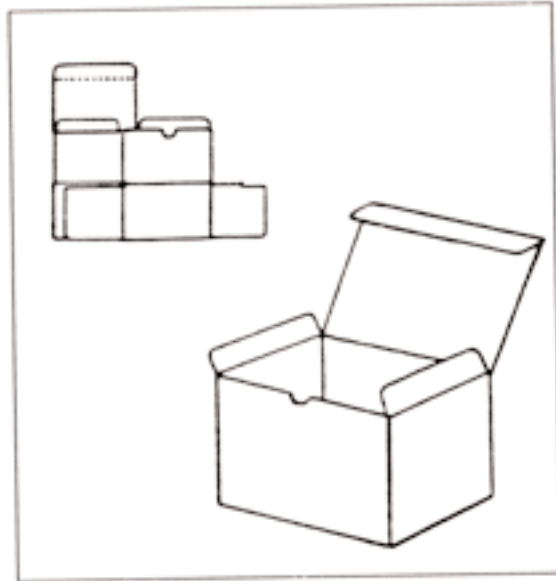
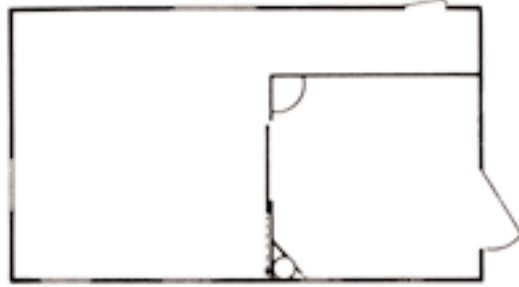

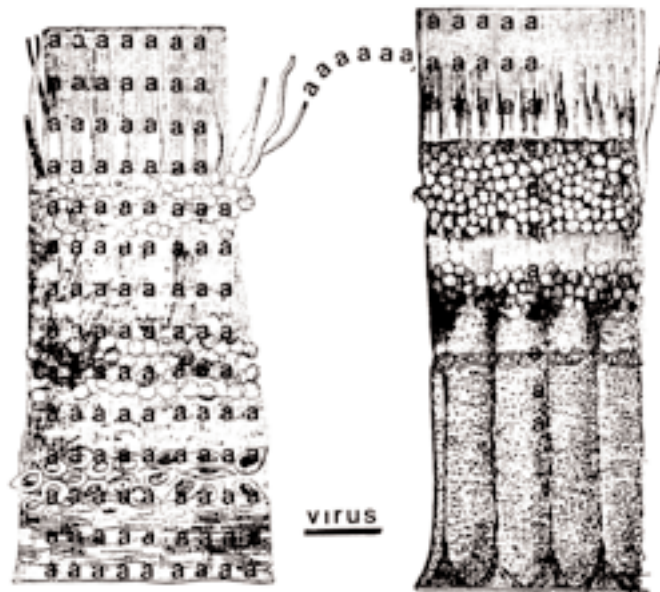



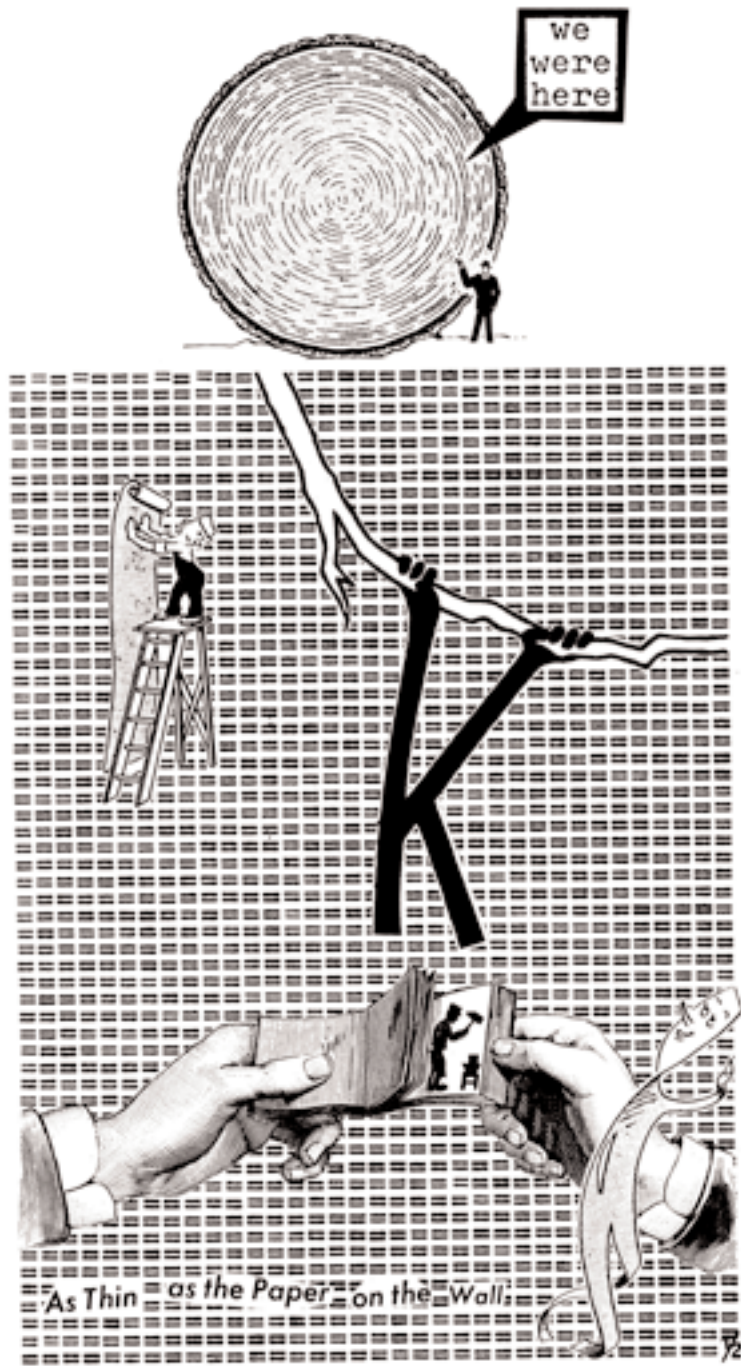





auto-phantom-limb-ditty

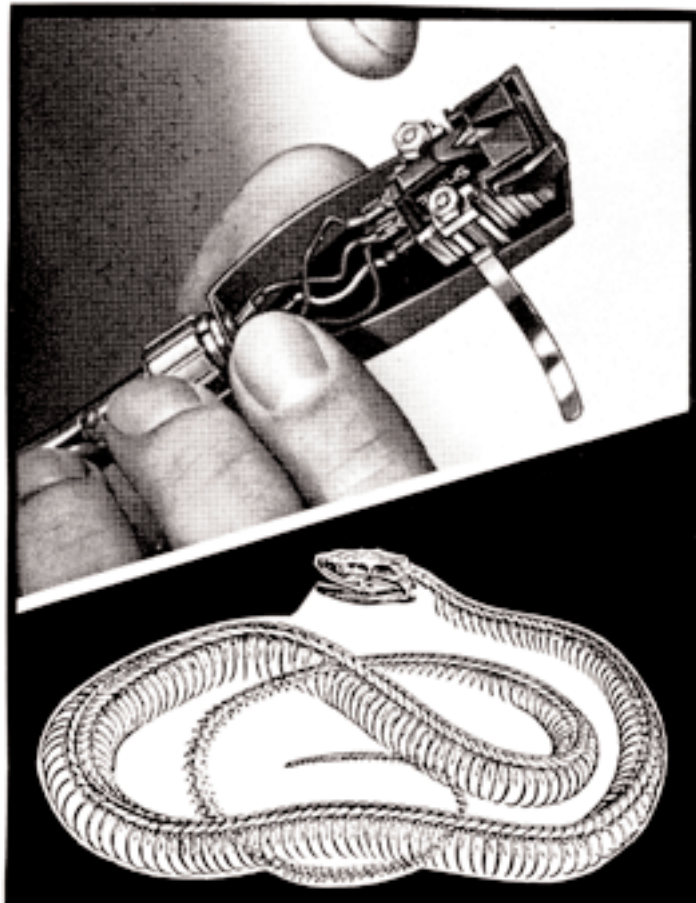

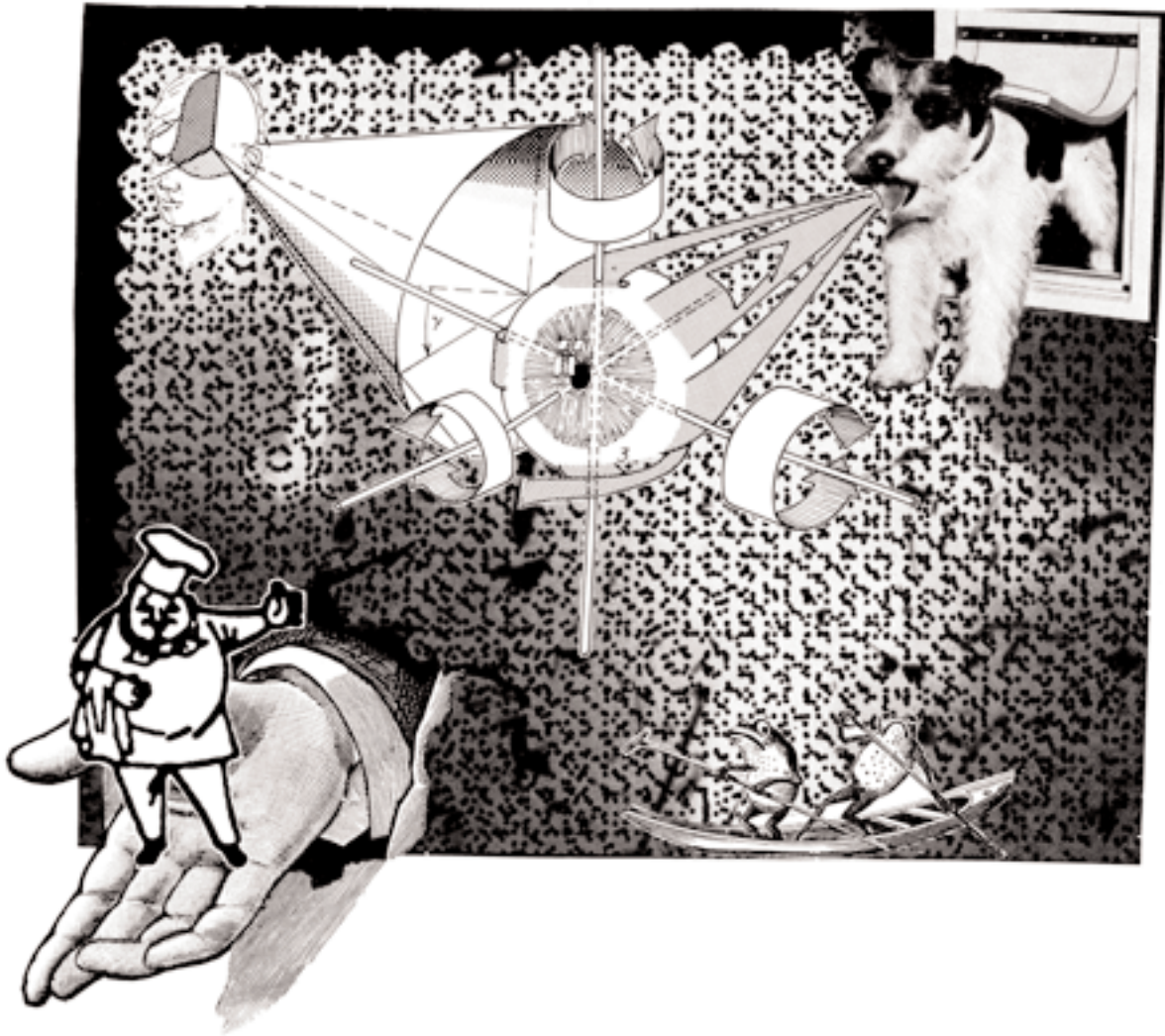



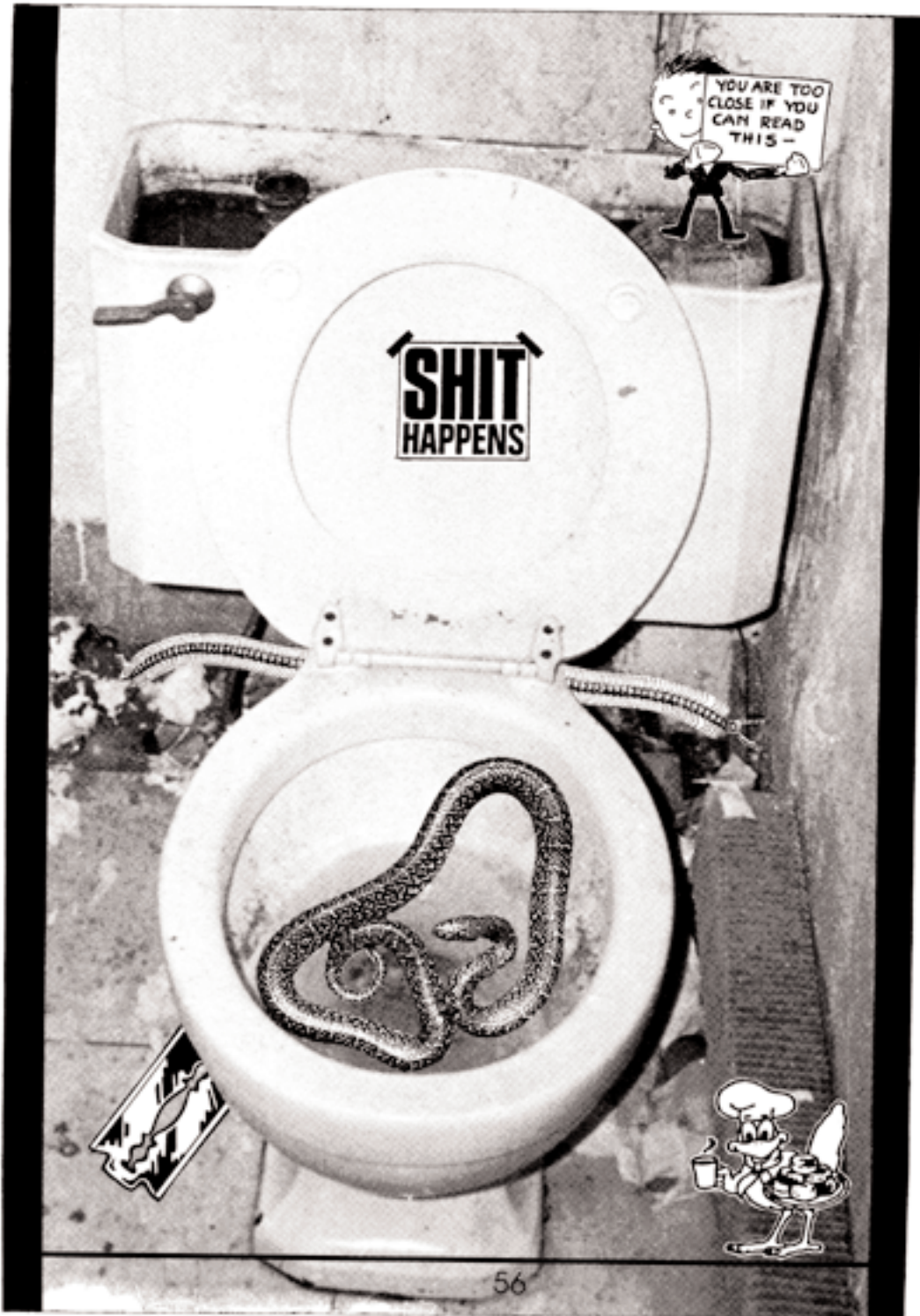

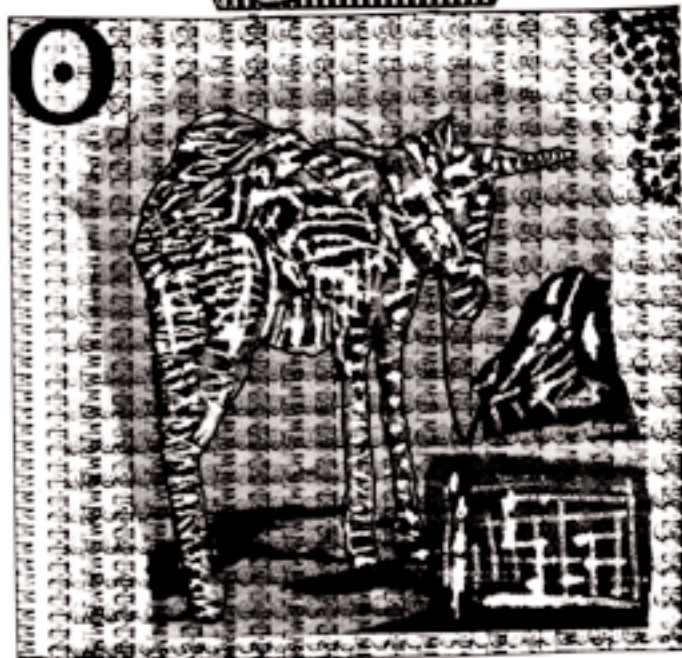

● zEn)      ....      (caRtoon







a stone ghost idiotically haunts the bogus hieroglyph

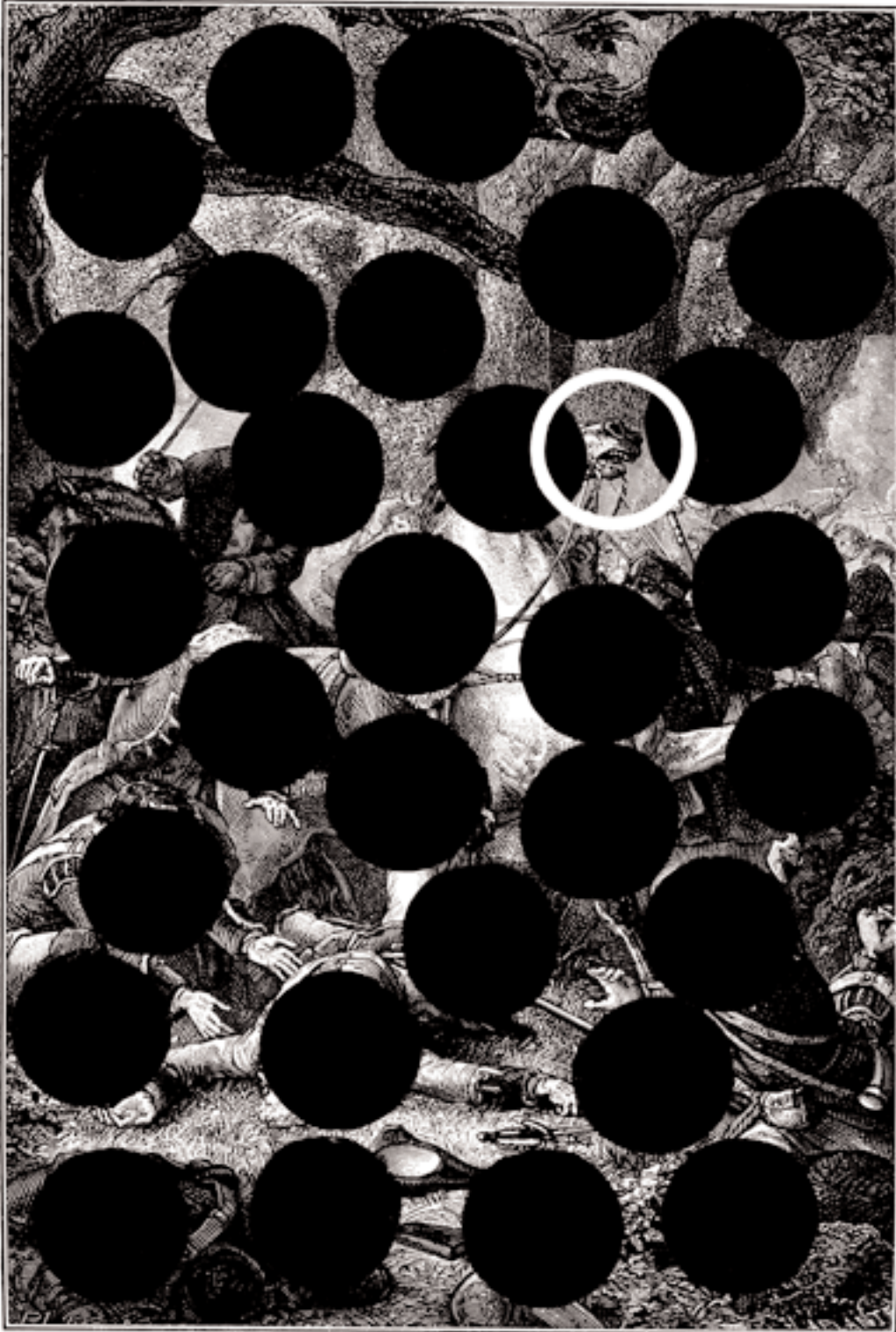

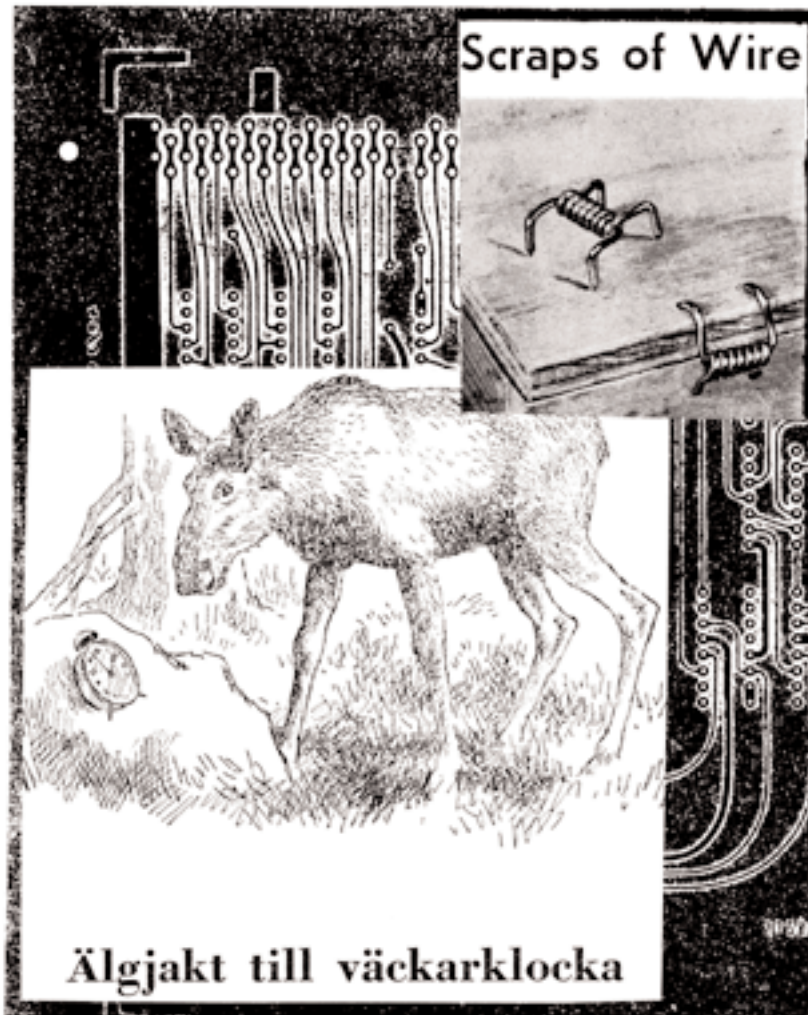

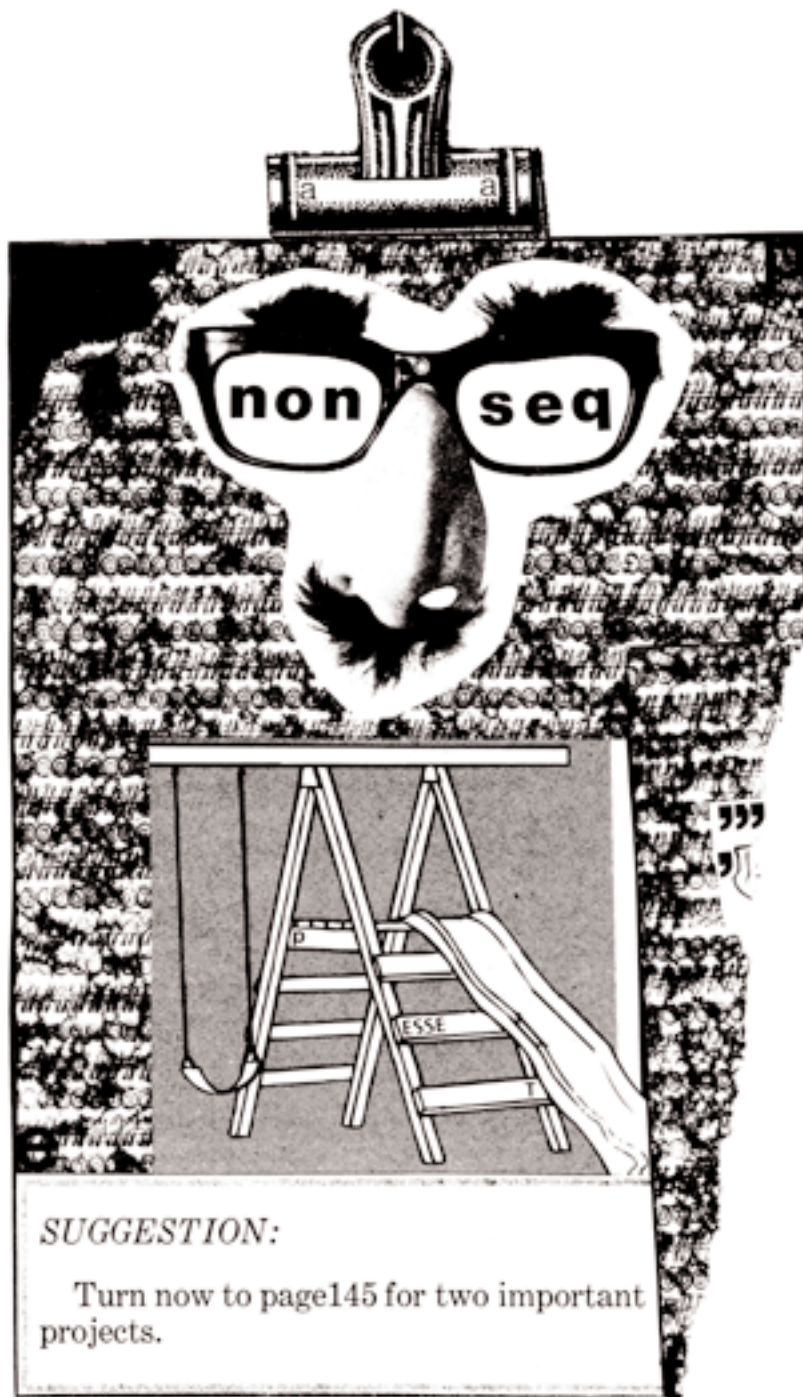

*SUGGESTION:*

Turn now to page145 for two important projects.



**DIRECTIONS:** Study the four pictures below. Three of them are related to each other. One picture **DOES NOT BELONG**. Select the one picture that is **DIFFERENT** from the others and write the name of that object in the space below marked "Puzzle Answer".

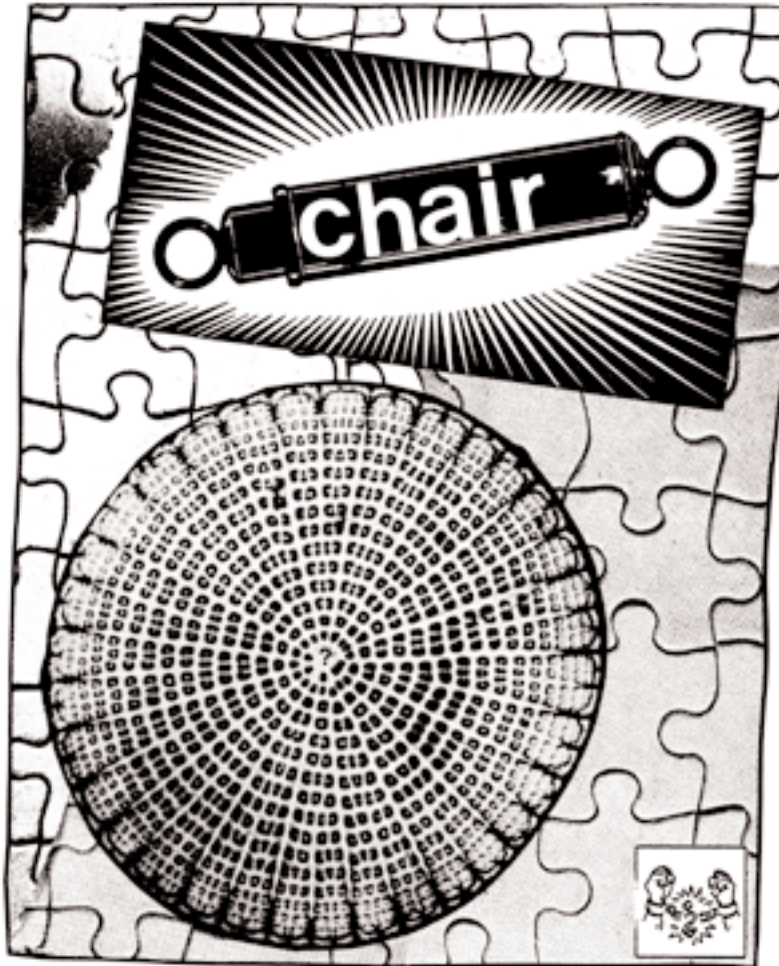
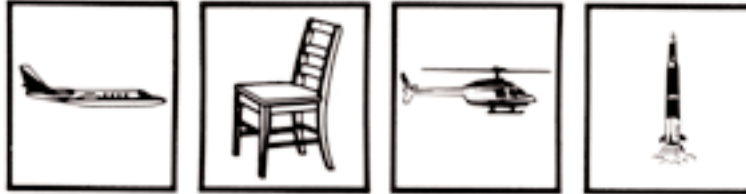





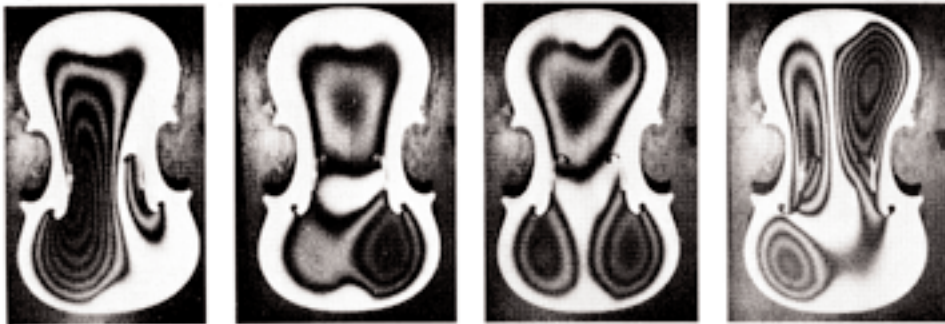

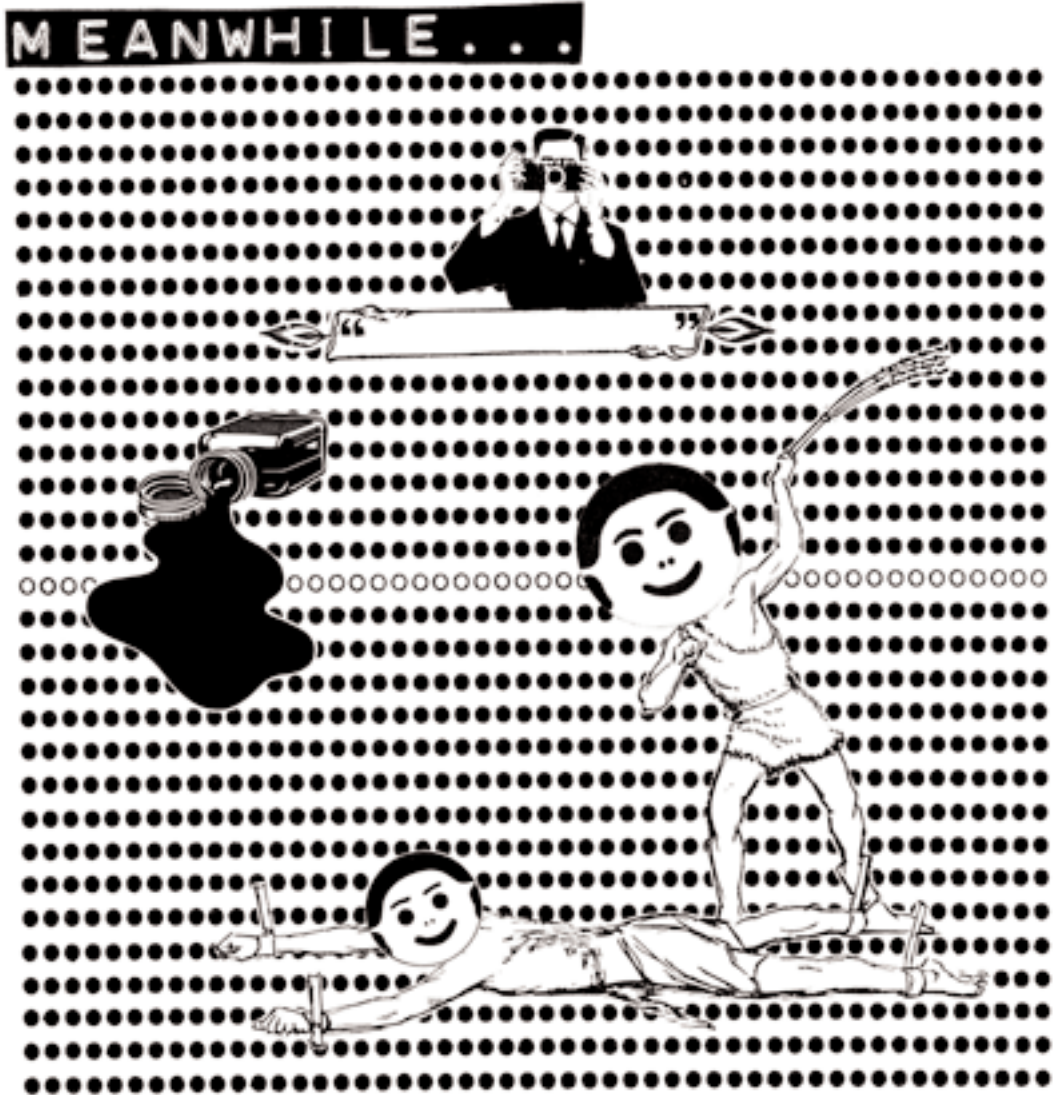

**/ubu editions**  
[ubu.com/ubu](http://ubu.com/ubu)